

A' DESIGN AWARD  
& COMPETITION  
**BRONZE WINNER**  
**2023**

MODUŁOWE







# MPS31 T0

# MODUŁOWE / UCHWYTY



80x12

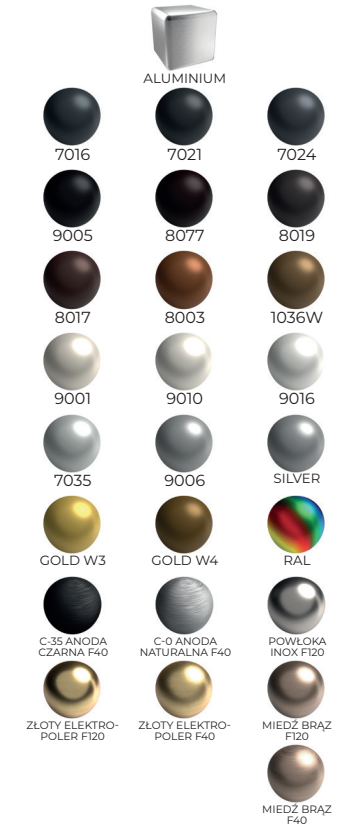
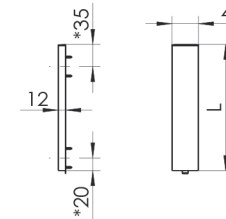
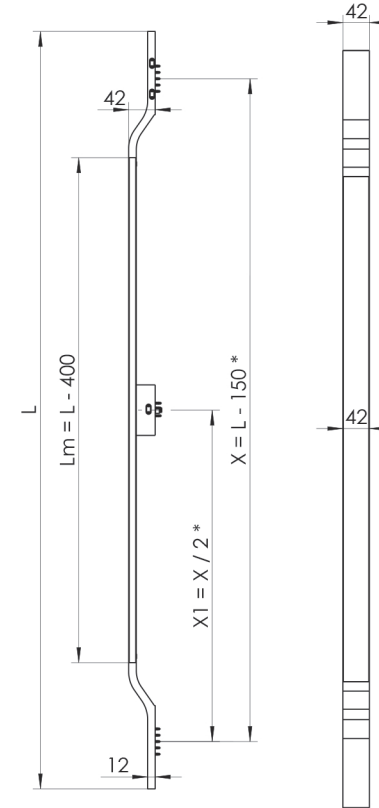
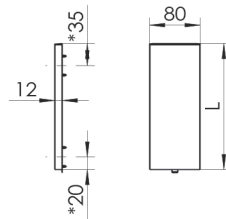
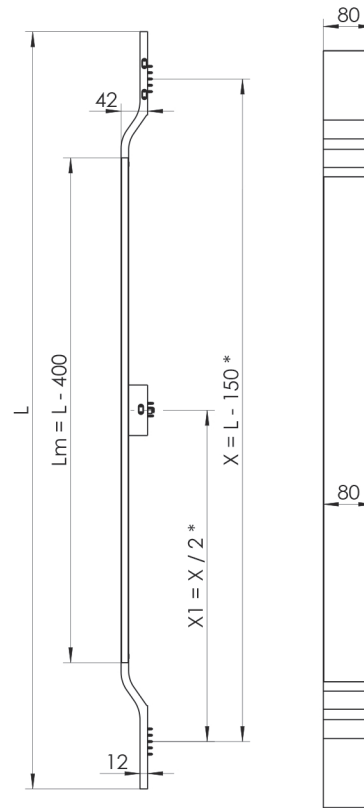
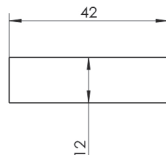
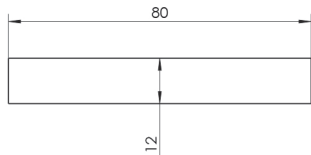

Zaślepki w uchwycie wykonane są w kolorze czarnym



MPS31 T0		
DŁUGOŚĆ L	ALUMINIUM	
	80x12	42x12
500 - 1000	•	•
1001 - 1600 (1 nóżka środkowa)	•	•
1601 - 3000 (2 nóżki środkowe)	•	•

- Produkt na zamówienie
- Produkt niedostępny

Dokładna obróbka pod mocowania dostępna na stronie [www.wala.pl](http://www.wala.pl)

DOSTAWKA PS01		
DŁUGOŚĆ L	ALUMINIUM	
	80x12	42x12
50 - 1200	•	•

Dla  $L > 600$  i  $L \leq 1200$ , w komplecie dodatkowe 1 mocowanie.  
Dla  $L > 1200$  w komplecie dodatkowe 2 mocowania.  
W powyższych przypadkach zalecane jest symetryczne rozłożenie dodatkowych mocowań, jednakże sposób montażu umożliwia ich dowolne położenie względem długości dostawki.



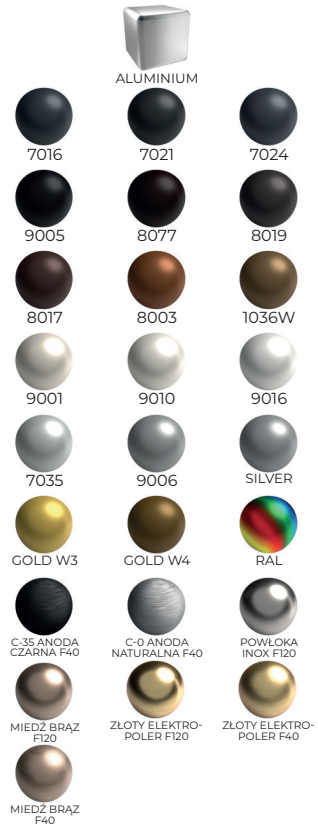

Zaślepki w uchwycie wykonane są w kolorze czarnym

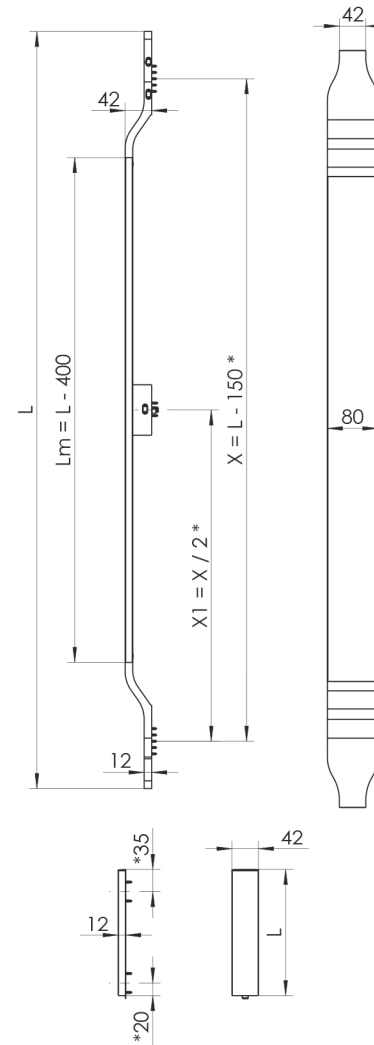
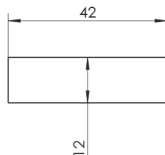
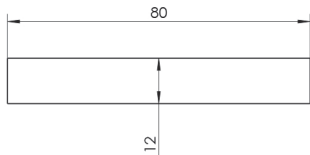

MPS31 T1	
DŁUGOŚĆ L	ALUMINIUM
500 - 1000	•
1001 - 1600 (1 nóżka środkowa)	•
1601 - 3000 (2 nóżki środkowe)	•

- Produkt na zamówienie
- Produkt niedostępny

Dokładna obróbka pod mocowania dostępna na stronie [www.waia.pl](http://www.waia.pl)

DOSTAWKA PS01	
DŁUGOŚĆ L	ALUMINIUM
50 - 1200	•

Dla  $L > 600$  i  $L \leq 1200$ , w komplecie dodatkowe 1 mocowanie.  
Dla  $L > 1200$  w komplecie dodatkowe 2 mocowania.  
W powyższych przypadkach zalecane jest symetryczne rozłożenie dodatkowych mocowań, jednakże sposób montażu umożliwia ich dowolne położenie względem długości dostawki.





# MPS31 T2

# MODUŁOWE / UCHWYTY

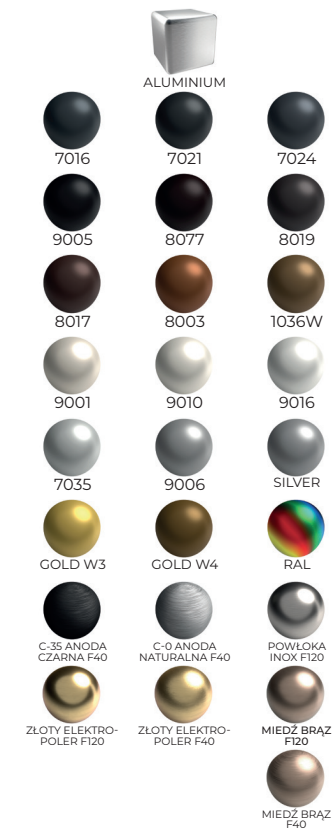
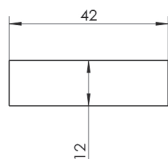
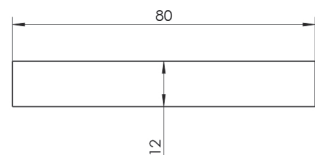
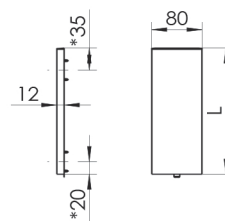
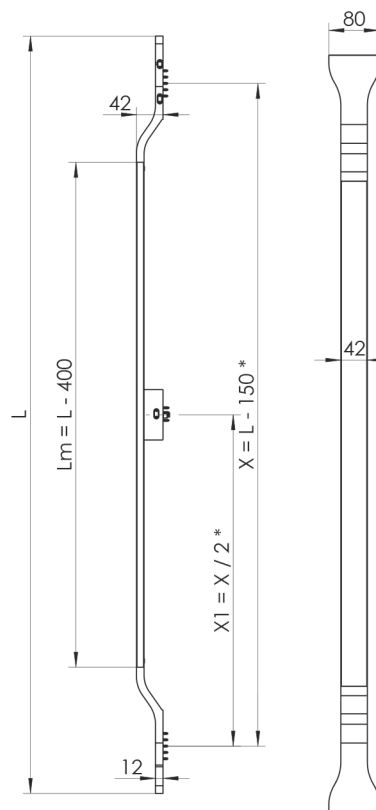

Zaślepki w uchwycie wykonane są w kolorze czarnym



MPS31 T2	
DŁUGOŚĆ L	ALUMINIUM
500 - 1000	•
1001 - 1600 (1 nóżka środkowa)	•
1601 - 3000 (2 nóżki środkowe)	•

- Produkt na zamówienie
- Produkt niedostępny

Dokładna obróbka pod mocowania dostępna na stronie [www.wala.pl](http://www.wala.pl)

DOSTAWKA PS01	
DŁUGOŚĆ L	ALUMINIUM
50 - 1200	•

Dla  $L > 600$  i  $L \leq 1200$ , w komplecie dodatkowe 1 mocowanie.  
Dla  $L > 1200$  w komplecie dodatkowe 2 mocowania.  
W powyższych przypadkach zalecane jest symetryczne rozłożenie dodatkowych mocowań, jednakże sposób montażu umożliwia ich dowolne położenie względem długości dostawki.



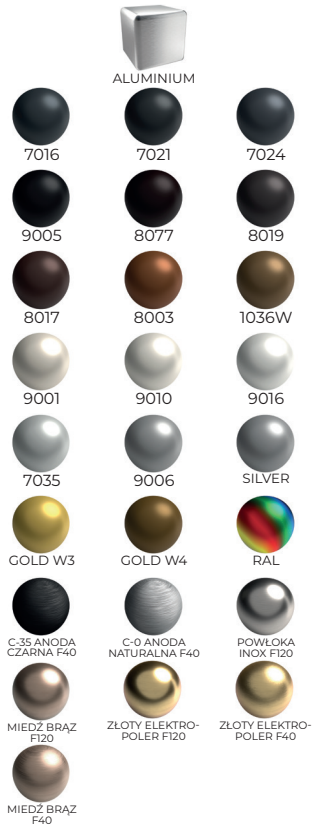

Zaślepki w uchwycie wykonane są w kolorze czarnym

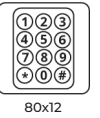
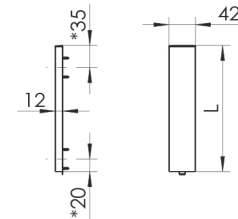
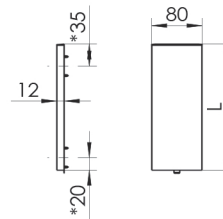
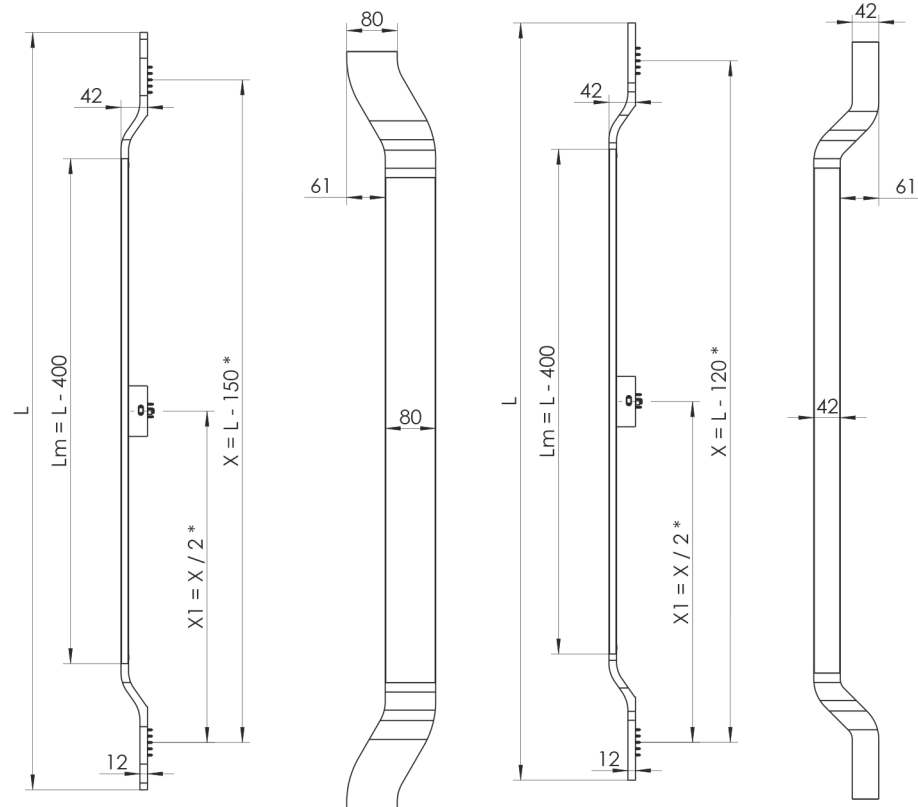
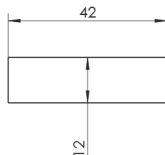
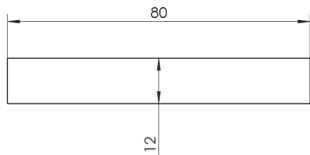

MPS31 T3		
DŁUGOŚĆ L	ALUMINIUM	
	80x12	42x12
500 - 1000	•	•
1001 - 1600 (1 nóżka środkowa)	•	•
1601 - 3000 (2 nóżki środkowe)	•	•

- Produkt na zamówienie
- Produkt niedostępny

Dokładna obróbka pod mocowania dostępna na stronie [www.wala.pl](http://www.wala.pl)

DOSTAWKA PS01		
DŁUGOŚĆ L	ALUMINIUM	
	80x12	42x12
50 - 1200	•	•

Dla  $L > 600$  i  $L \leq 1200$ , w komplecie dodatkowe 1 mocowanie.  
Dla  $L > 1200$  w komplecie dodatkowe 2 mocowania.  
W powyższych przypadkach zalecane jest symetryczne rozłożenie dodatkowych mocowań, jednakże sposób montażu umożliwi ich dowolne położenie względem długości dostawki.





# MPS31 T3 L/P

# MODUŁOWE / UCHWYTY



80x12



DO WYBORU  
STRONNOŚĆ  
LEWA LUB PRAWA

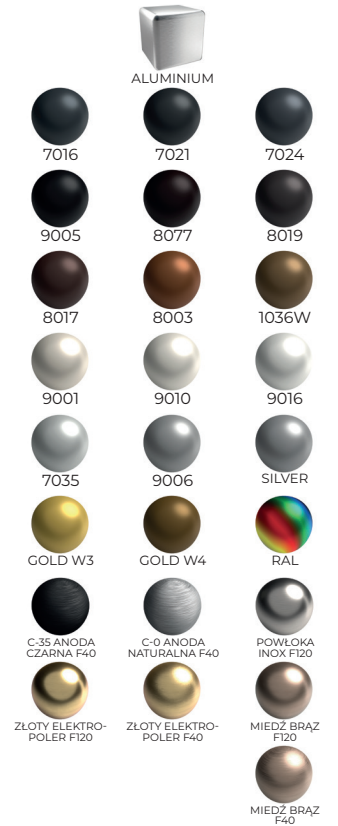
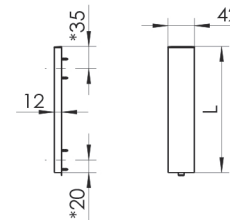
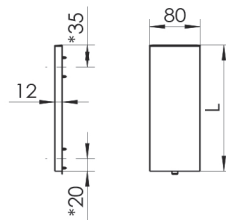
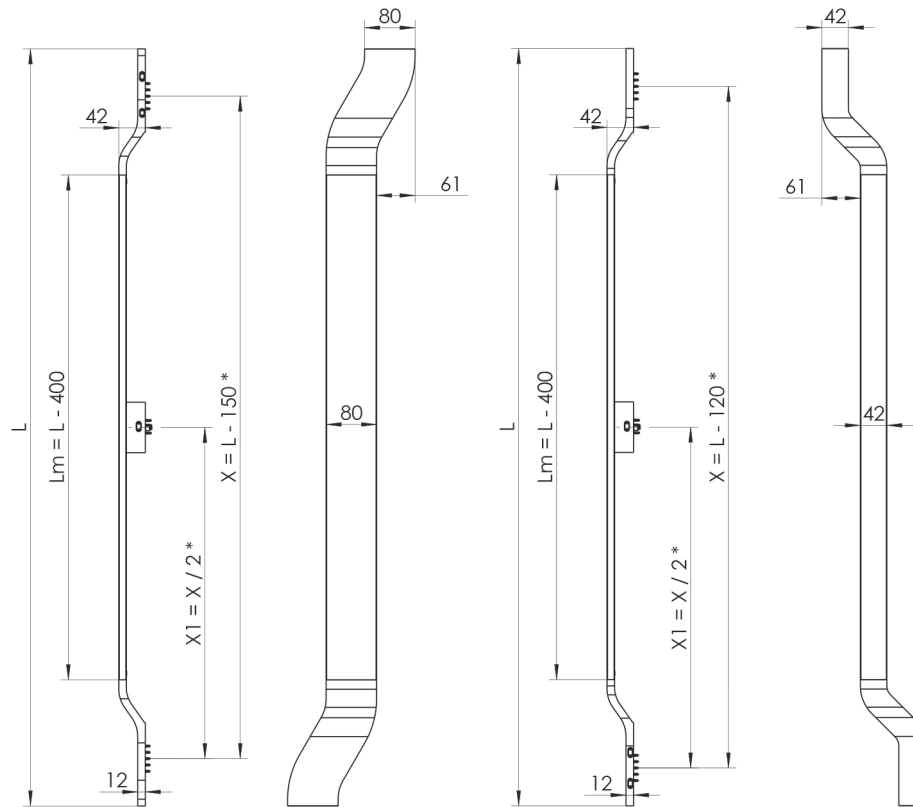
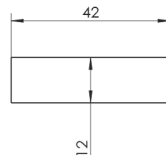
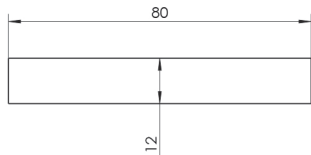

Zaślepki w uchwycie wykonane są w kolorze czarnym



MPS31 T3 L/P		
DŁUGOŚĆ L	ALUMINIUM	
	80x12	42x12
500 - 1000	•	•
1001 - 1600 (1 nóżka środkowa)	•	•
1601 - 3000 (2 nóżki środkowe)	•	•

DOSTAWKA PS01		
DŁUGOŚĆ L	ALUMINIUM	
	80x12	42x12
50 - 1200	•	•

- Produkt na zamówienie
- Produkt niedostępny

Dokładna obróbka pod mocowania dostępna na stronie [www.wala.pl](http://www.wala.pl)

Dla  $L > 600$  i  $L \leq 1200$ , w komplecie dodatkowe 1 mocowanie.  
Dla  $L > 1200$  w komplecie dodatkowe 2 mocowania.  
W powyższych przypadkach zalecane jest symetryczne rozłożenie dodatkowych mocowań, jednakże sposób montażu umożliwiają ich dowolne położenie względem długości dostawki.



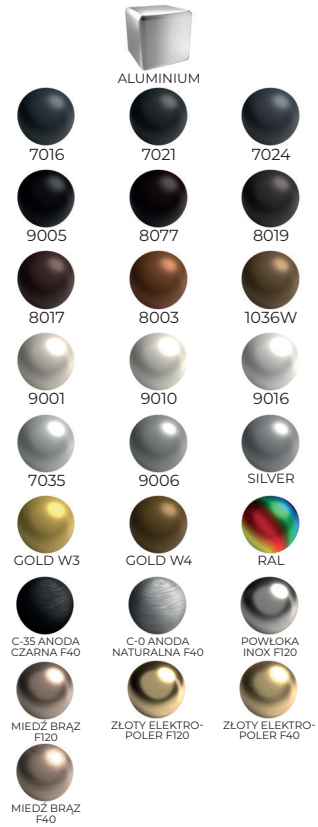

Zaślepki w uchwycie wykonane są w kolorze czarnym

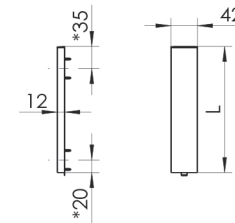
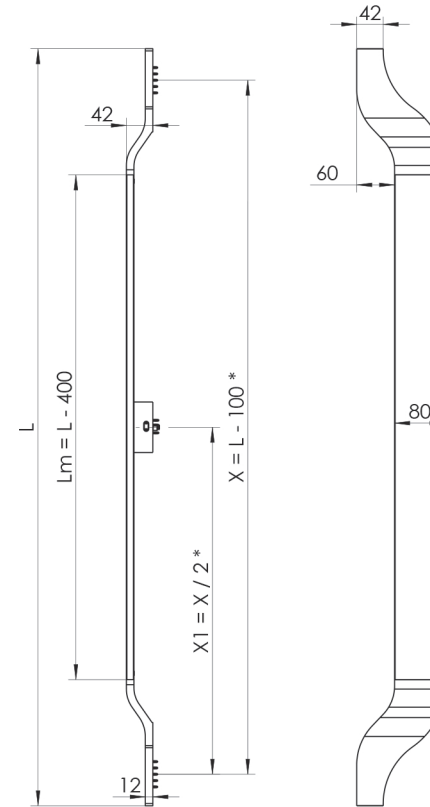
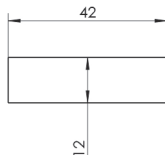
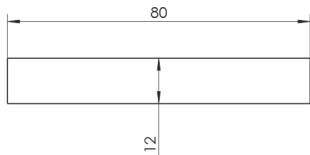

MPS31 T4	
DŁUGOŚĆ L	ALUMINIUM
500 - 1000	80x12 •
1001 - 1600 (1 nóżka środkowa)	•
1601 - 3000 (2 nóżki środkowe)	•

- Produkt na zamówienie
- Produkt niedostępny

Dokładna obróbka pod mocowania dostępna na stronie [www.wala.pl](http://www.wala.pl)

DOSTAWKA PS01	
DŁUGOŚĆ L	ALUMINIUM
50 - 1200	42x12 •

Dla  $L > 600$  i  $L \leq 1200$ , w komplecie dodatkowe 1 mocowanie.  
Dla  $L > 1200$  w komplecie dodatkowe 2 mocowania.  
W powyższych przypadkach zalecane jest symetryczne rozłożenie dodatkowych mocowań, jednakże sposób montażu umożliwia ich dowolne położenie względem długości dostawki.







# MPS31 T4 L/P

# MODUŁOWE / UCHWYTY



DO WYBORU  
STRONNOŚĆ  
LEWA LUB PRAWA

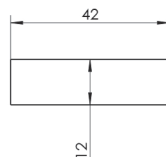
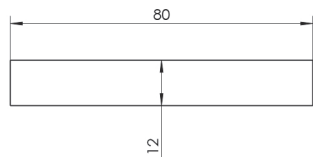
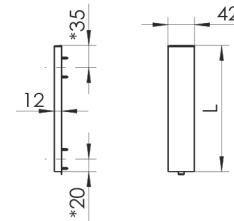
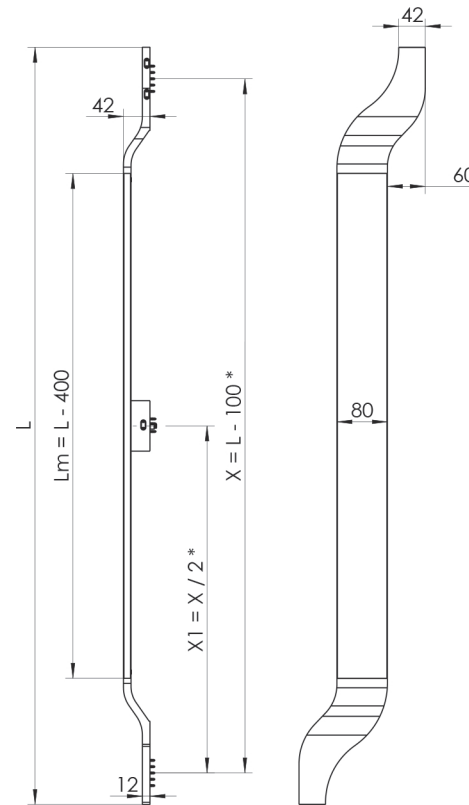

MPS31 T4 L/P	
DŁUGOŚĆ L	ALUMINIUM
500 - 1000	•
1001 - 1600 (1 nóżka środkowa)	•
1601 - 3000 (2 nóżki środkowe)	•

- Produkt na zamówienie
- Produkt niedostępny

Dokładna obróbka pod mocowania dostępna na stronie [www.wala.pl](http://www.wala.pl)

DOSTAWKA PS01	
DŁUGOŚĆ L	ALUMINIUM
50 - 1200	•

Dla  $L > 600$  i  $L \leq 1200$ , w komplecie dodatkowe 1 mocowanie.  
Dla  $L > 1200$  w komplecie dodatkowe 2 mocowania.  
W powyższych przypadkach zalecane jest symetryczne rozłożenie dodatkowych mocowań, jednakże sposób montażu umożliwia ich dowolne położenie względem długości dostawki.

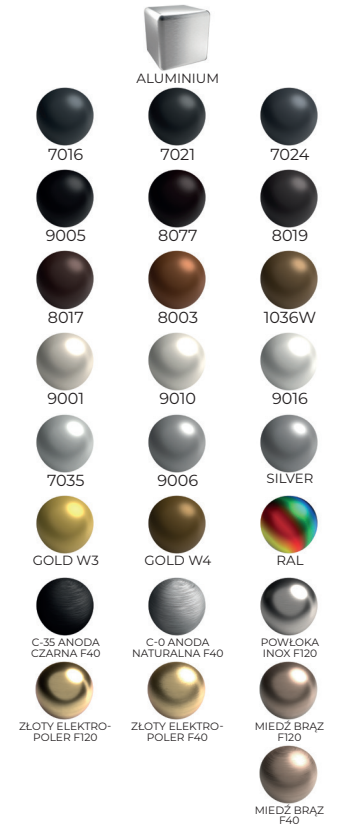

Zaślepki w uchwycie wykonane są w kolorze czarnym



CZARNE



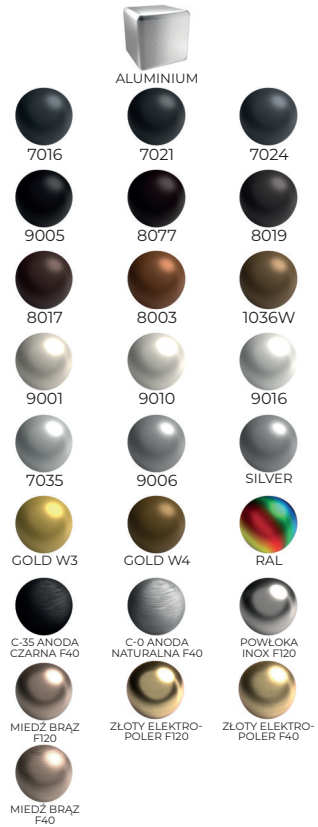

Zaślepki w uchwycie wykonane są w kolorze czarnym

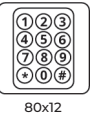
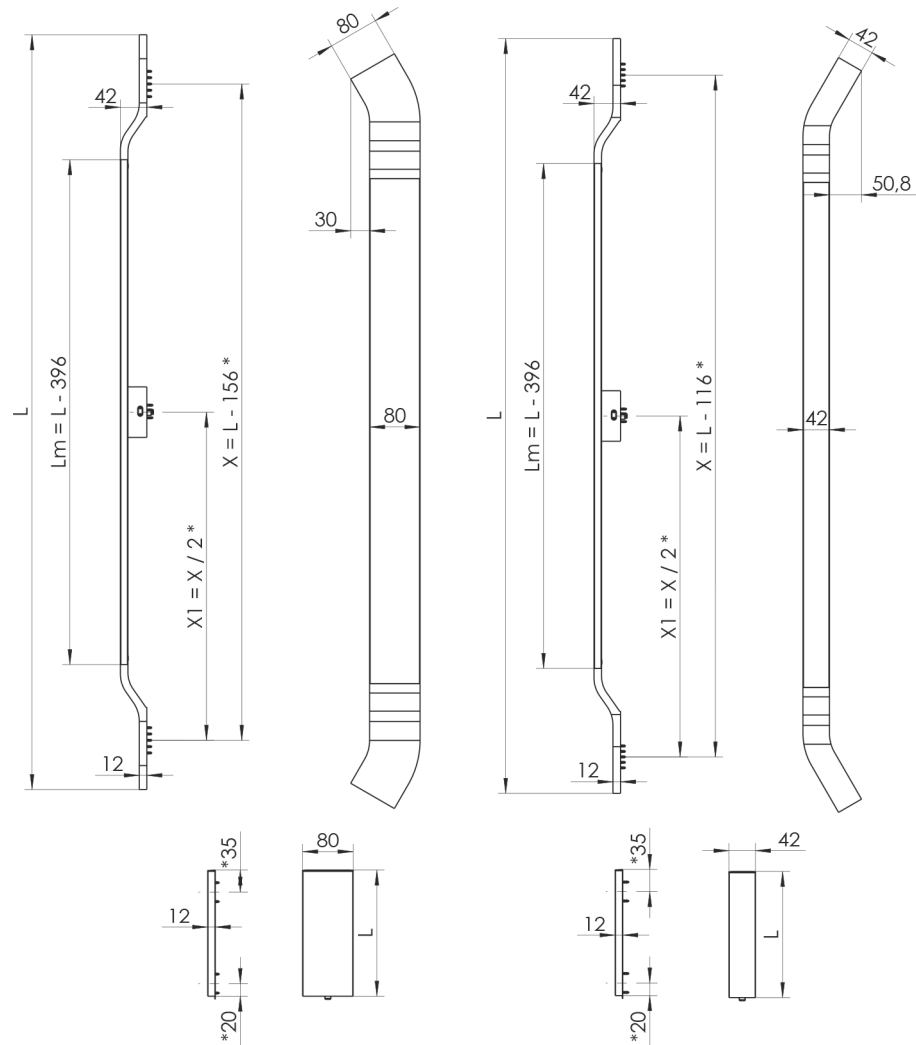

MPS31 T5		
DŁUGOŚĆ L	ALUMINIUM	
	80x12	42x12
500 - 1000	•	•
1001 - 1600 (1 nóżka środkowa)	•	•
1601 - 3000 (2 nóżki środkowe)	•	•

- Produkt na zamówienie
- Produkt niedostępny

Dokładna obróbka pod mocowania dostępna na stronie [www.wala.pl](http://www.wala.pl)

DOSTAWKA PS01		
DŁUGOŚĆ L	ALUMINIUM	
	80x12	42x12
50 - 1200	•	•

Dla  $L > 600$  i  $L \leq 1200$ , w komplecie dodatkowe 1 mocowanie. Dla  $L > 1200$  w komplecie dodatkowe 2 mocowania. W powyższych przypadkach zalecane jest symetryczne rozłożenie dodatkowych mocowań, jednakże sposób montażu umożliwia ich dowolne położenie względem długości dostawki.





# MPS31 T5 L/P

# MODUŁOWE / UCHWYTY



80x12



DO WYBORU  
STRONNOŚĆ  
LEWA LUB PRAWA

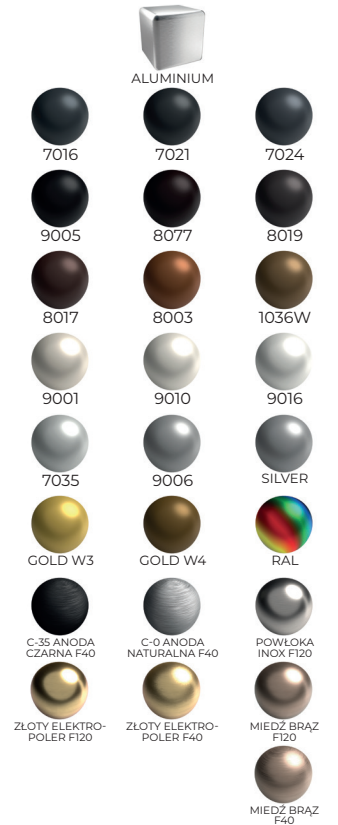
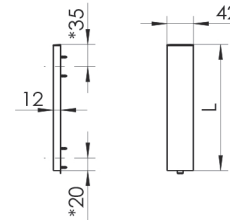
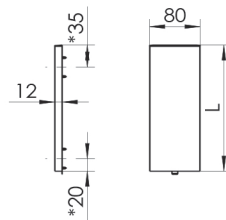
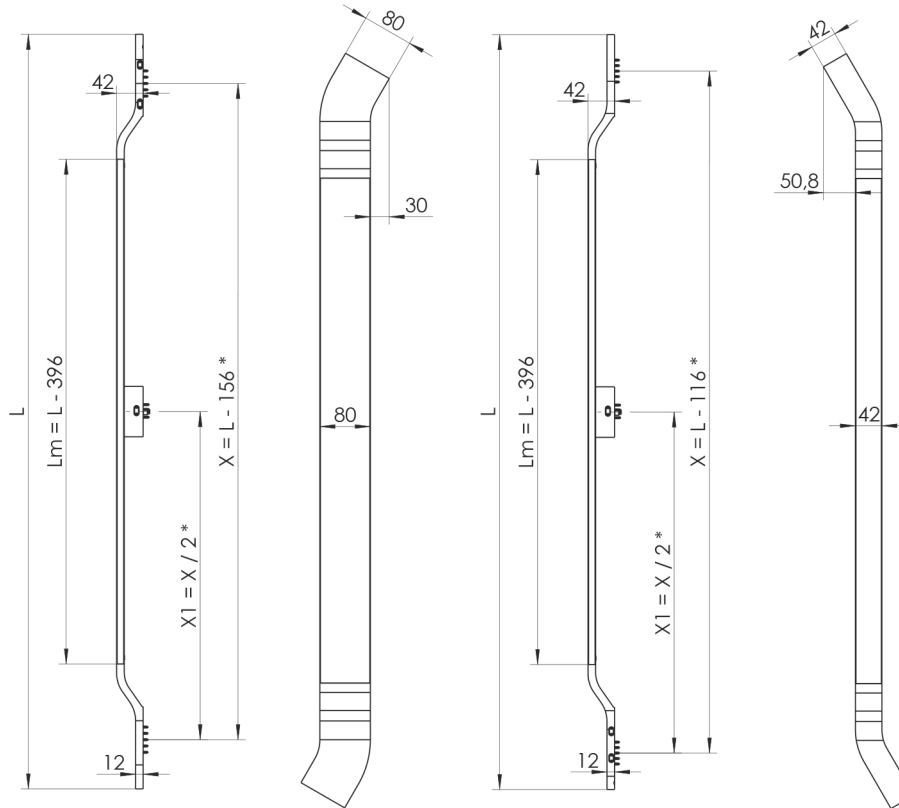
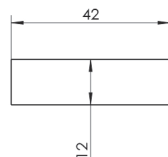
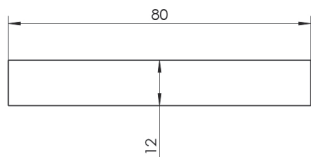

Zaślepki w uchwycie wykonane są w kolorze czarnym



CZARNE

MPS31 T5 L/P		
DŁUGOŚĆ L	ALUMINIUM	
	80x12	42x12
500 - 1000	•	•
1001 - 1600 (1 nóżka środkowa)	•	•
1601 - 3000 (2 nóżki środkowe)	•	•

- Produkt na zamówienie
- Produkt niedostępny

Dokładna obróbka pod mocowania dostępna na stronie [www.wala.pl](http://www.wala.pl)

DOSTAWKA PS01		
DŁUGOŚĆ L	ALUMINIUM	
	80x12	42x12
50 - 1200	•	•

Dla L > 600 i L ≤ 1200, w komplecie dodatkowe 1 mocowanie. Dla L > 1200 w komplecie dodatkowe 2 mocowania. W powyższych przypadkach zalecane jest symetryczne rozłożenie dodatkowych mocowań, jednakże sposób montażu umożliwia ich dowolne położenie względem długości dostawki.



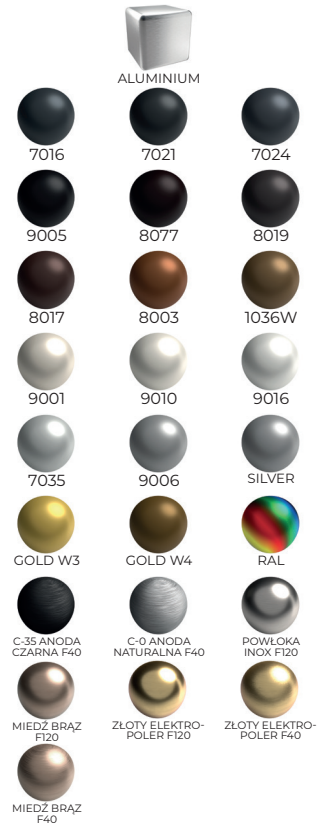

Zaślepki w uchwycie wykonane są w kolorze czarnym

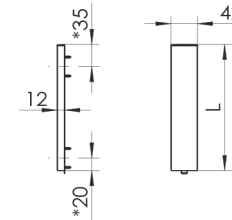
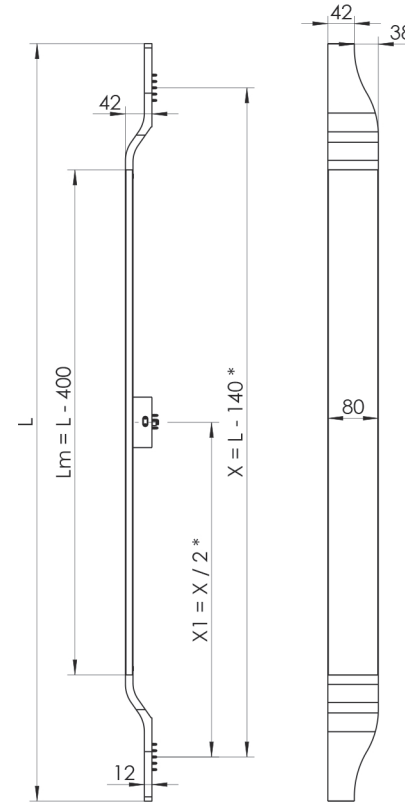
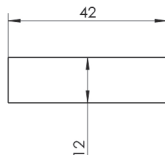
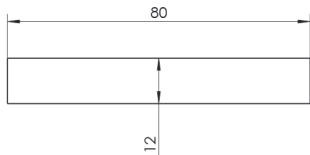

MPS31 T6	
DŁUGOŚĆ L	ALUMINIUM
500 - 1000	•
1001 - 1600 (1 nóżka środkowa)	•
1601 - 3000 (2 nóżki środkowe)	•

- Produkt na zamówienie
- Produkt niedostępny

Dokładna obróbka pod mocowania dostępna na stronie [www.waia.pl](http://www.waia.pl)

DOSTAWKA PS01	
DŁUGOŚĆ L	ALUMINIUM
50 - 1200	•

Dla L > 600 i L ≤ 1200, w komplecie dodatkowe 1 mocowanie.  
Dla L > 1200 w komplecie dodatkowe 2 mocowania.  
W powyższych przypadkach zalecane jest symetryczne rozłożenie dodatkowych mocowań, jednakże sposób montażu umożliwia ich dowolne położenie względem długości dostawki.





# MPS31 T6 L/P

# MODUŁOWE / UCHWYTY



DO WYBORU  
STRONNOŚĆ  
LEWA LUB PRAWA

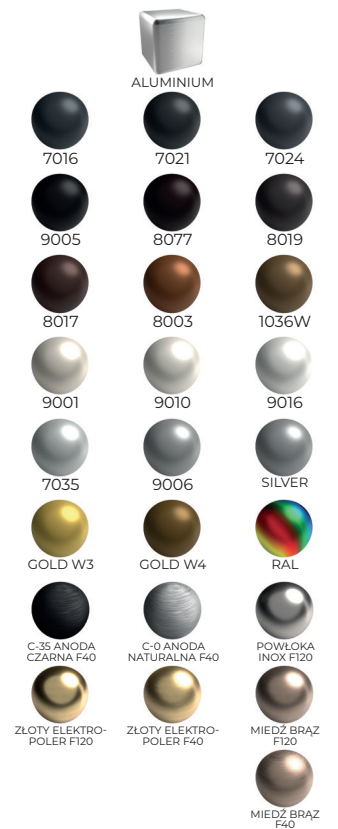
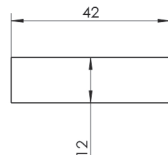
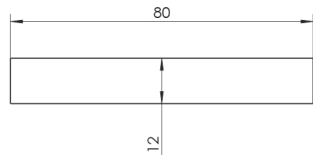
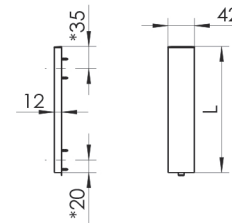
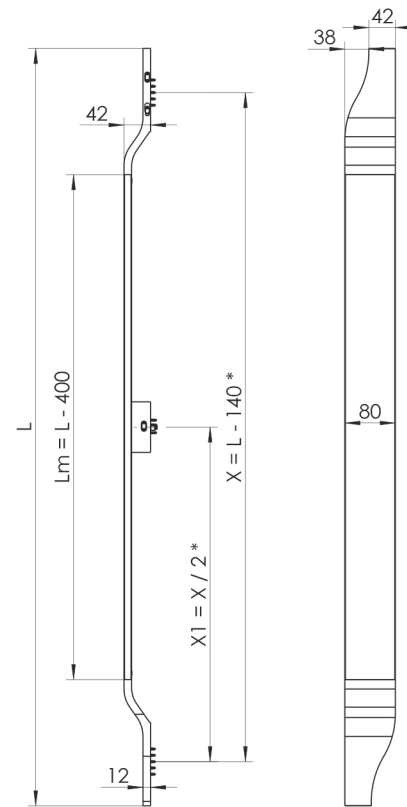

Zaślepki w uchwycie wykonane są w kolorze czarnym  
  
CZARNE

MPS31 T6 L/P	
DŁUGOŚĆ L	ALUMINIUM
500 - 1000	80x12
1001 - 1600 (1 nóżka środkowa)	•
1601 - 3000 (2 nóżki środkowe)	•

• Produkt na zamówienie  
◦ Produkt niedostępny

Dokładna obróbka pod mocowania dostępna na stronie [www.wala.pl](http://www.wala.pl)

DOSTAWKA PS01	
DŁUGOŚĆ L	ALUMINIUM
50 - 1200	42x12
	•

Dla L > 600 i L ≤ 1200, w komplecie dodatkowe 1 mocowanie.  
Dla L > 1200 w komplecie dodatkowe 2 mocowania.  
W powyższych przypadkach zalecane jest symetryczne rozłożenie dodatkowych mocowań, jednakże sposób montażu umożliwia ich dowolne położenie względem długości dostawki.



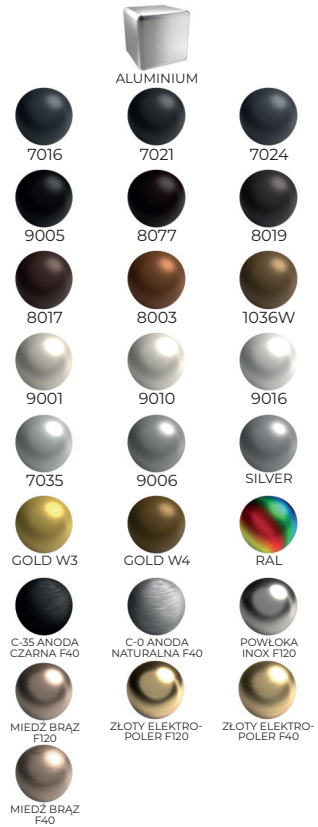

Zaślepki w uchwycie wykonane są w kolorze czarnym

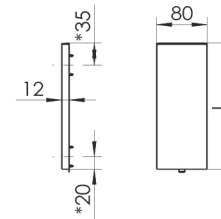
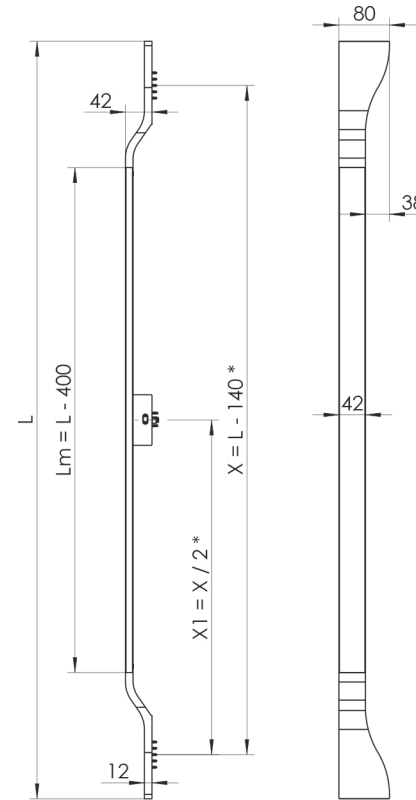
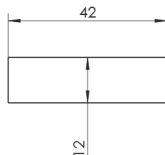
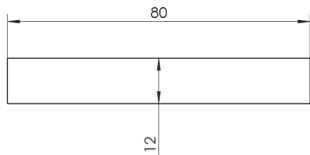

MPS31 T7	
DŁUGOŚĆ L	ALUMINIUM
500 - 1000	•
1001 - 1600 (1 nóżka środkowa)	•
1601 - 3000 (2 nóżki środkowe)	•

- Produkt na zamówienie
- Produkt niedostępny

Dokładna obróbka pod mocowania dostępna na stronie [www.waia.pl](http://www.waia.pl)

DOSTAWKA PS01	
DŁUGOŚĆ L	ALUMINIUM
50 - 1200	•

Dla L > 600 i L ≤ 1200, w komplecie dodatkowe 1 mocowanie.  
Dla L > 1200 w komplecie dodatkowe 2 mocowania.  
W powyższych przypadkach zalecane jest symetryczne rozłożenie dodatkowych mocowań, jednakże sposób montażu umożliwia ich dowolne położenie względem długości dostawki.





# MPS31 T7 L/P

# MODUŁOWE / UCHWYTY



DO WYBORU  
STRONNOŚĆ  
LEWA LUB PRAWA

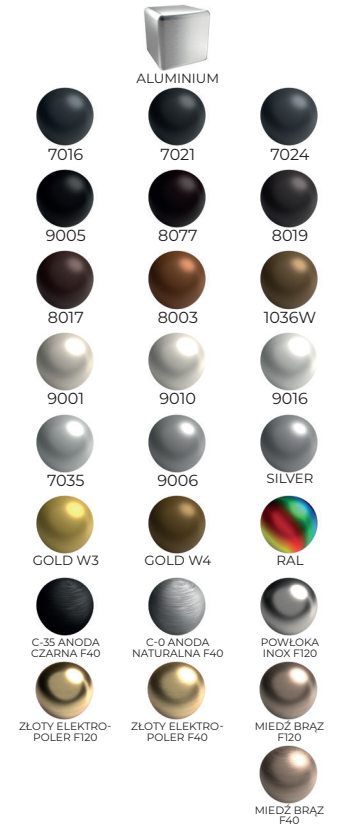
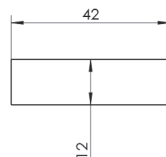
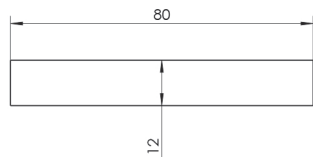
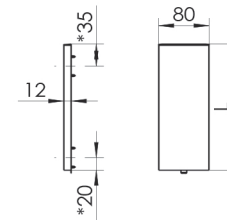
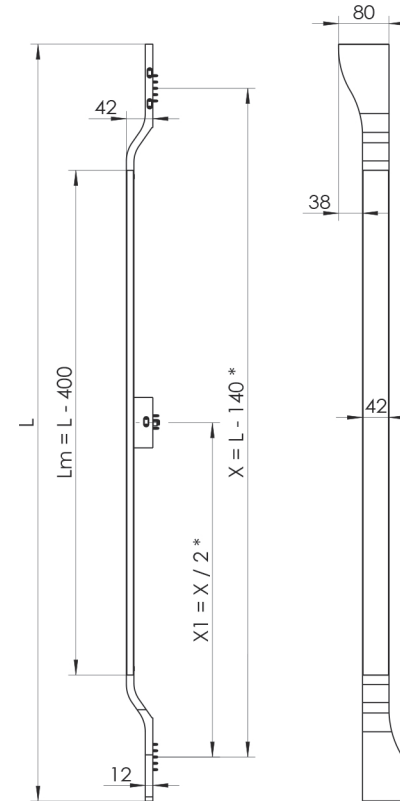

Zaślepki w uchwycie wykonane są w kolorze czarnym



MPS31 T7 L/P	
DŁUGOŚĆ L	ALUMINIUM
500 - 1000	•
1001 - 1600 (1 nóżka środkowa)	•
1601 - 3000 (2 nóżki środkowe)	•

- Produkt na zamówienie
- Produkt niedostępny

Dokładna obróbka pod mocowania dostępna na stronie [www.wala.pl](http://www.wala.pl)

DOSTAWKA PS01	
DŁUGOŚĆ L	ALUMINIUM
50 - 1200	•

Dla  $L > 600$  i  $L \leq 1200$ , w komplecie dodatkowe 1 mocowanie.  
Dla  $L > 1200$  w komplecie dodatkowe 2 mocowania.  
W powyższych przypadkach zalecane jest symetryczne rozłożenie dodatkowych mocowań, jednakże sposób montażu umożliwia ich dowolne położenie względem długości dostawki.



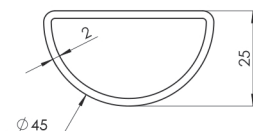
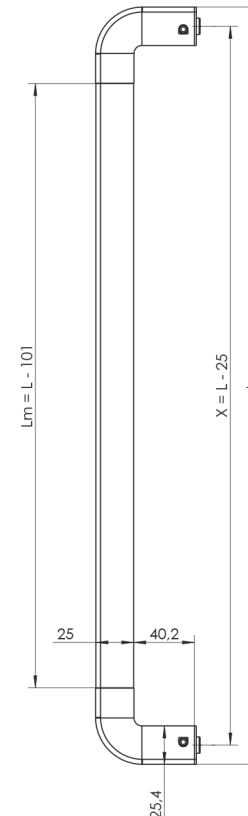
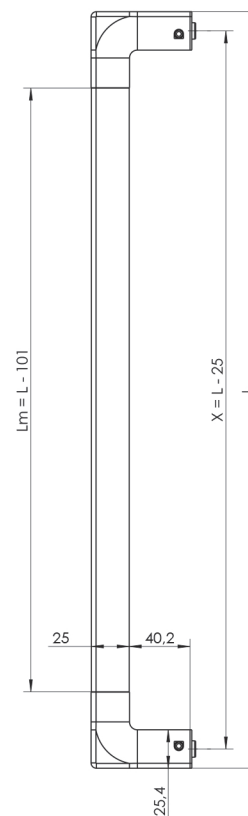
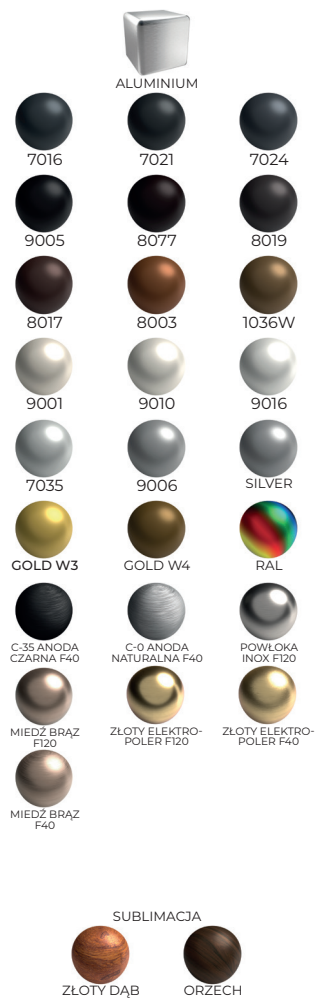

DLUGOŚĆ L	ROZSTAW X	ALUMINIUM
300 - 1200	L-25	• Ø45x25

- Produkt na zamówienie
- Produkt niedostępny







# MQ90

## MODUŁOWE / UCHWYTY



40x40  
40x20



40x40

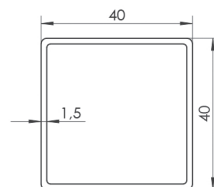
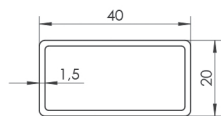
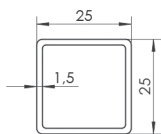
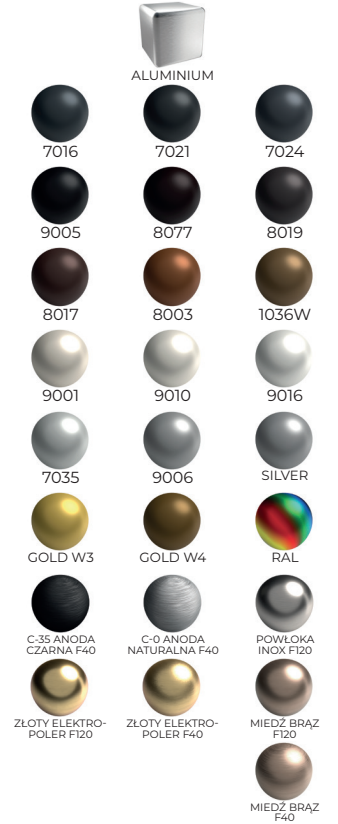
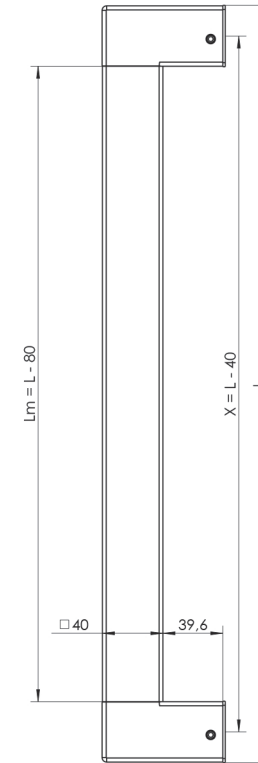
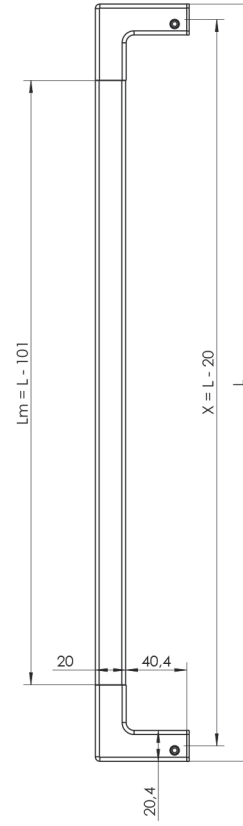
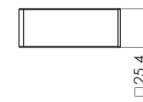
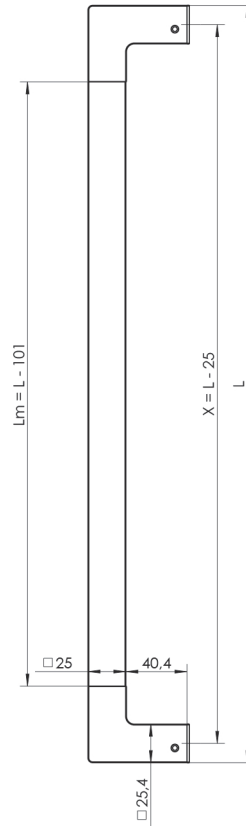

DŁUGOŚĆ L	ALUMINIUM		
	25x25	40x20	40x40
300 - 1200	•	•	•
1201 - 2300	◦	◦	•
ROZSTAW X	L-25	L-20	L-40

• Produkt na zamówienie  
◦ Produkt niedostępny





- ALUMINIUM
- 7016
  - 7021
  - 7024
  - 9005
  - 8077
  - 8019
  - 8017
  - 8003
  - 1036W
  - 9001
  - 9010
  - 9016
  - 7035
  - 9006
  - SILVER
  - GOLD W3
  - GOLD W4
  - RAL
  - C-35 ANODA CZARNA F40
  - C-0 ANODA NATURALNA F40
  - POWŁOKA INOX F120
  - MIEDŹ BRAŹ F120
  - ZŁOTY ELEKTRO-POLER F120
  - ZŁOTY ELEKTRO-POLER F40
  - MIEDŹ BRAŹ F40

- SUBLIMACJA
- ZŁOTY DĄB
  - ORZECH

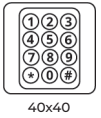
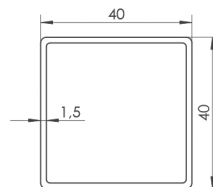
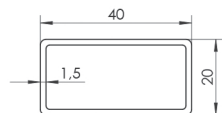
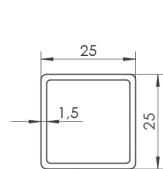
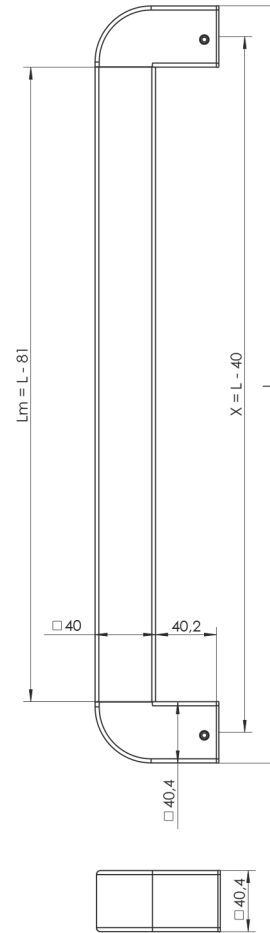
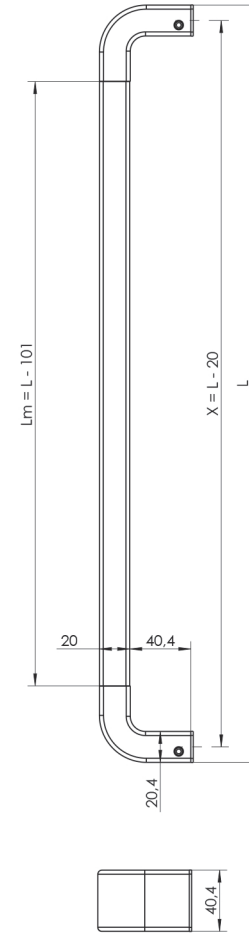
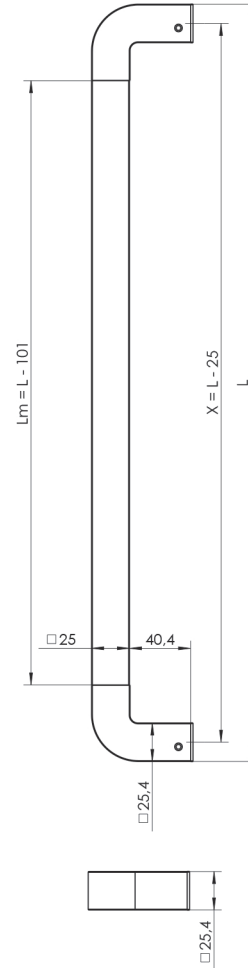

DŁUGOŚĆ L	ALUMINIUM		
	25x25	40x20	40x40
300 - 1200	•	•	•
1201 - 2300	◦	◦	•
ROZSTAW X	L-25	L-20	L-40

- Produkt na zamówienie
- Produkt niedostępny





# MQ90J / MQ90CJ

## MODUŁOWE / UCHWYTY

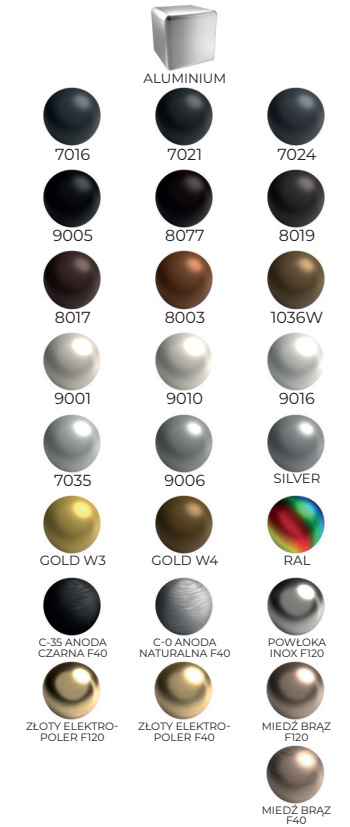
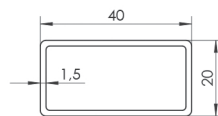
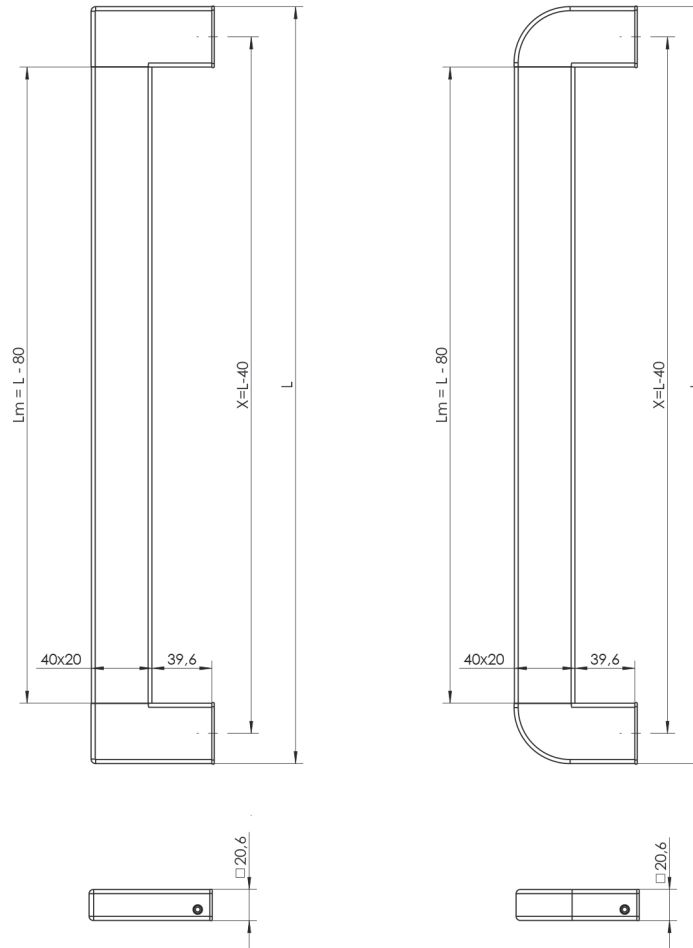

DŁUGOŚĆ L	ALUMINIUM
300 - 2300	40x20
ROZSTAW X	L-40

- Produkt na zamówienie
- Produkt niedostępny







**WALA Sp. z o.o.**  
**ul. Parkowa 16**  
**43-365 Wilkowice**  
**tel. +48 33 82 72 390**  
**wala@wala.pl**  
**www.wala.pl**